

Y-125

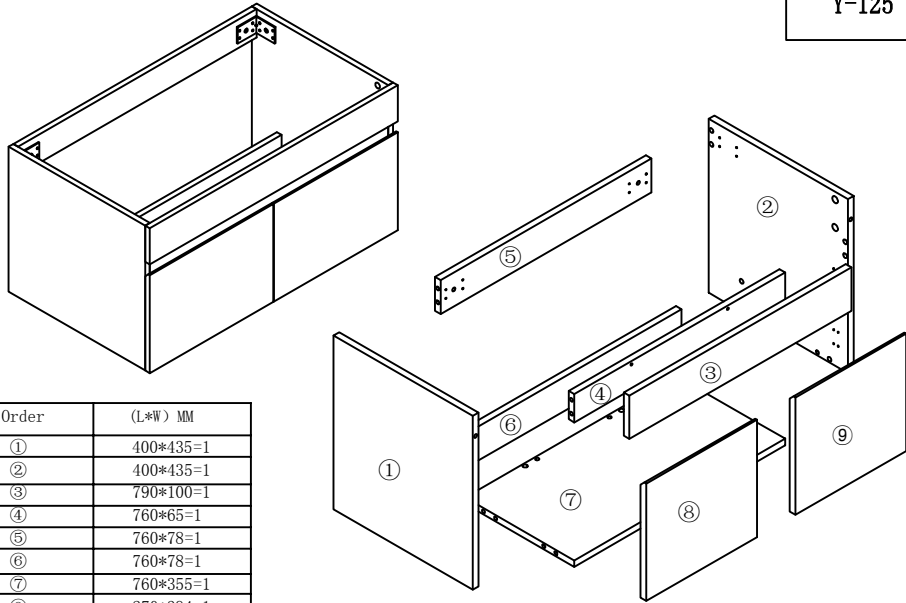

Order	(L*W) MM
①	400*435=1
②	400*435=1
③	790*100=1
④	760*65=1
⑤	760*78=1
⑥	760*78=1
⑦	760*355=1
⑧	270*394=1
⑨	270*394=1

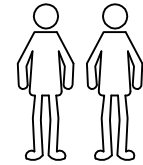
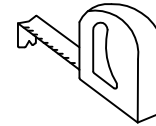
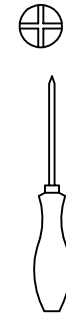
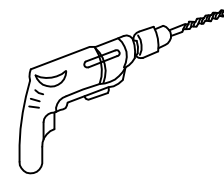
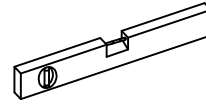

A



φ15*13mm
=22

B

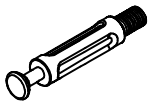

φ8*40mm
=22

C

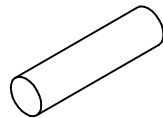

φ8*40mm
=8

F

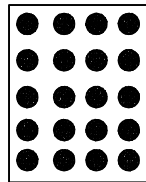

φ20*0.3mm=22

G

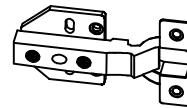

25*65*25mm
=4

H-H

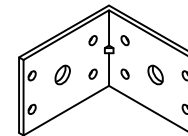

67*67*40mm
=2

I



4*14mm
=40

J

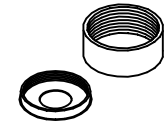

φ20*8mm
=2

K



φ10*43mm
=2

L

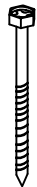

φ6*70mm
=2

M-M



4*20mm
=2

P



φ18*4mm
=4

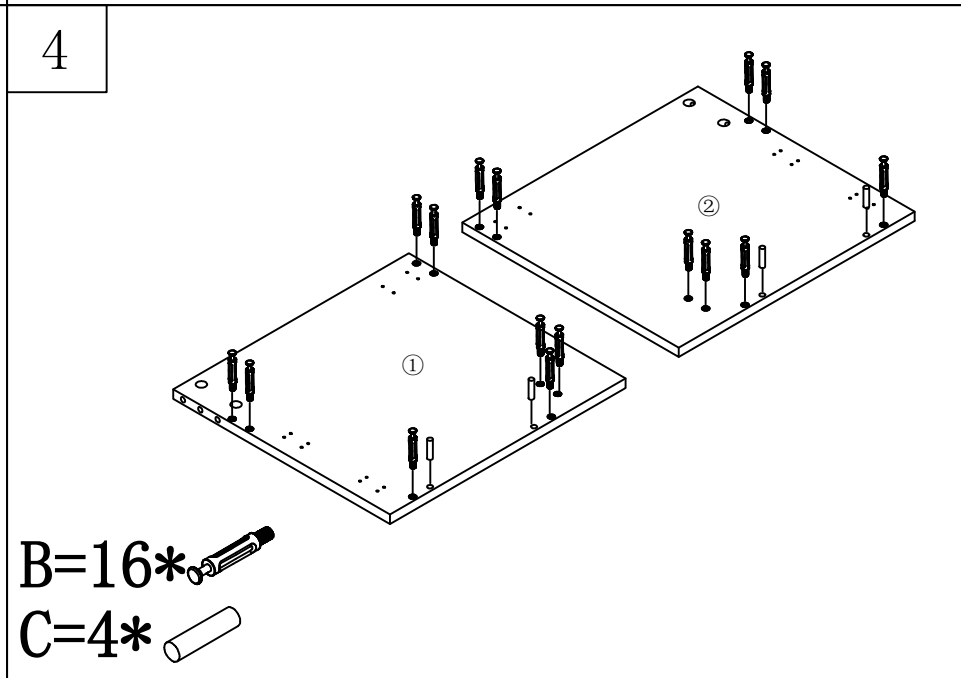
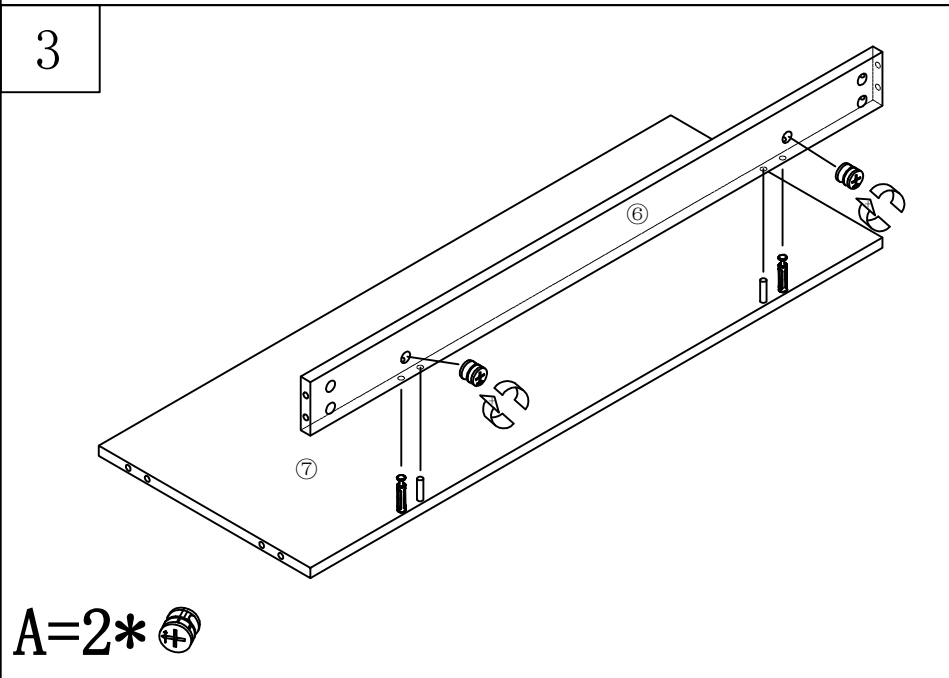
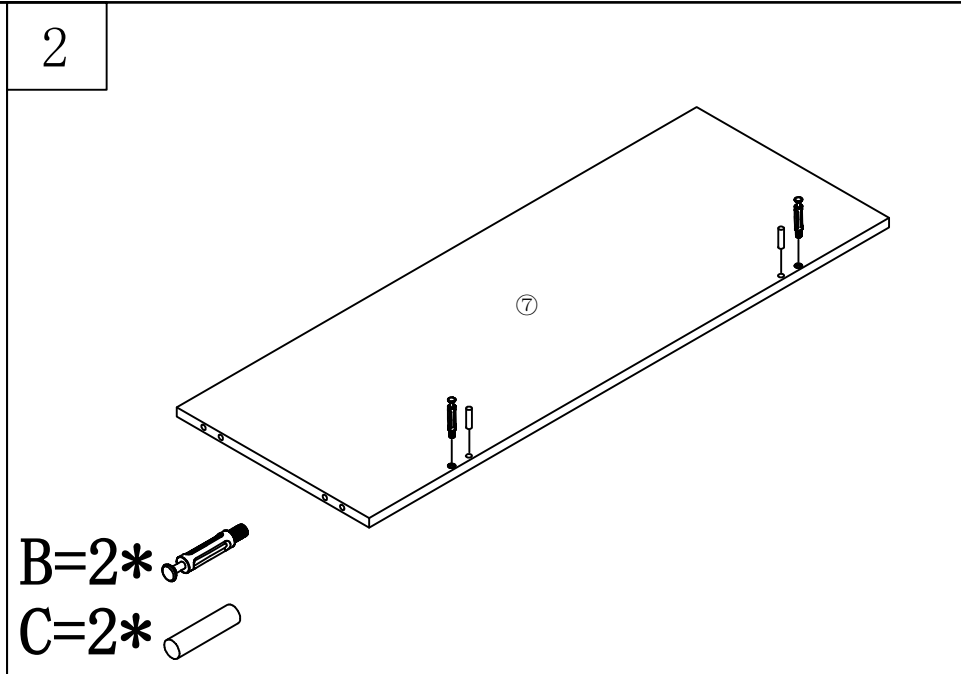
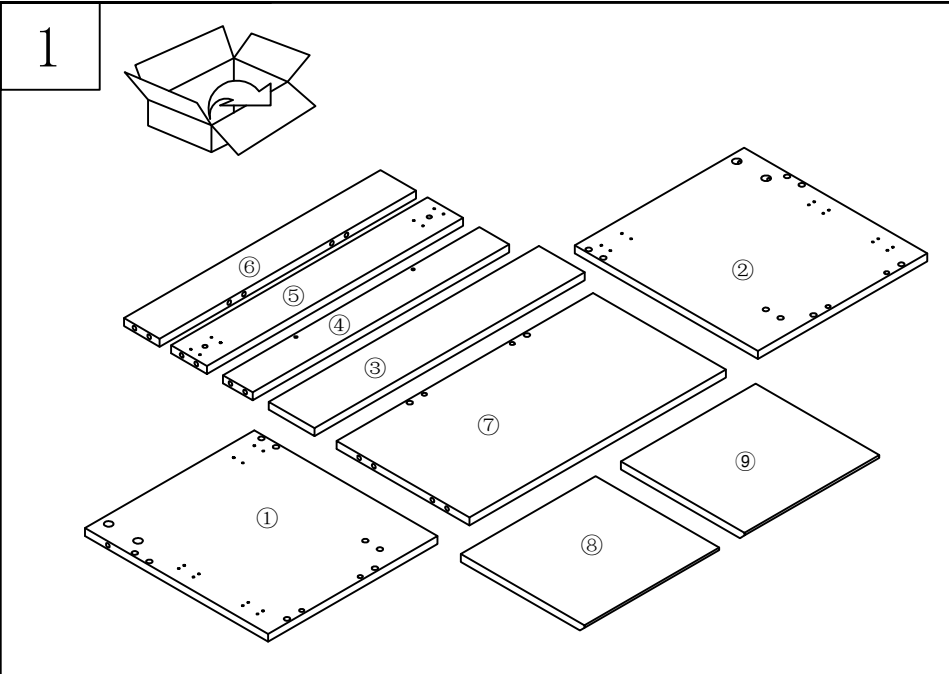

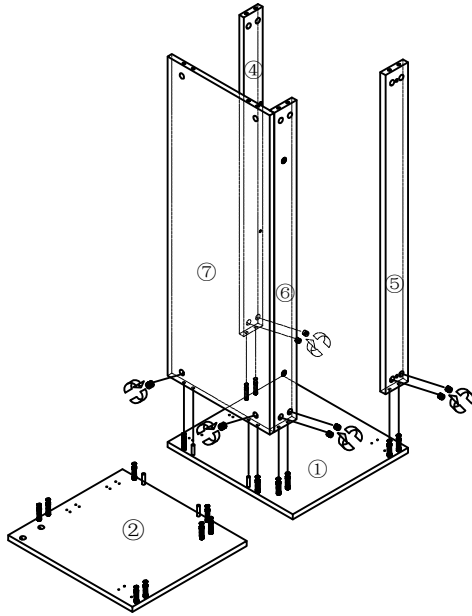

5

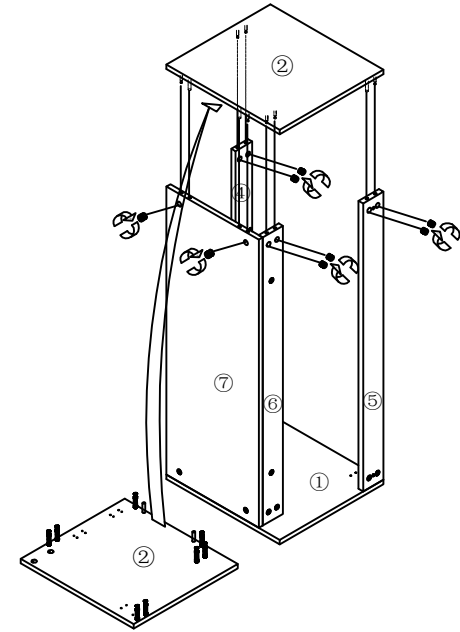

A=8* 

6



A=8* 

7

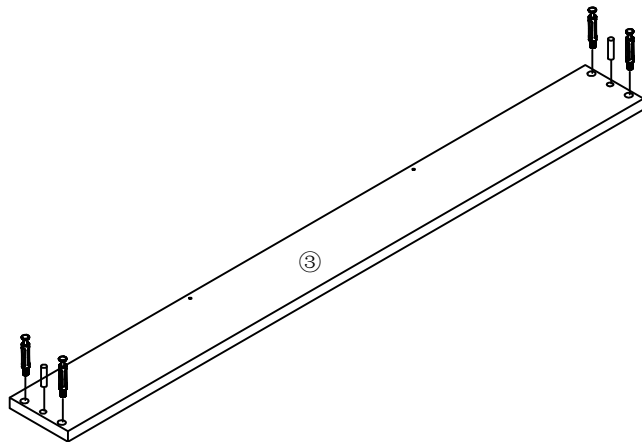



B=4* 

C=2* 

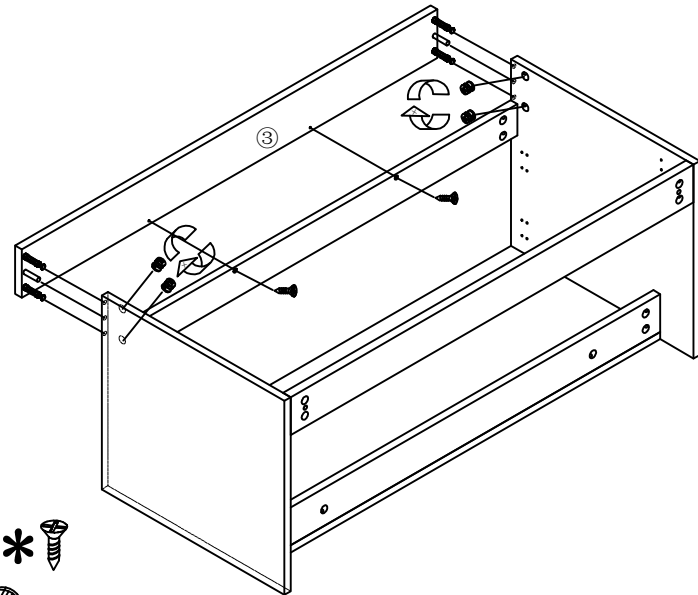
8





M-M=2* 

A=4* 

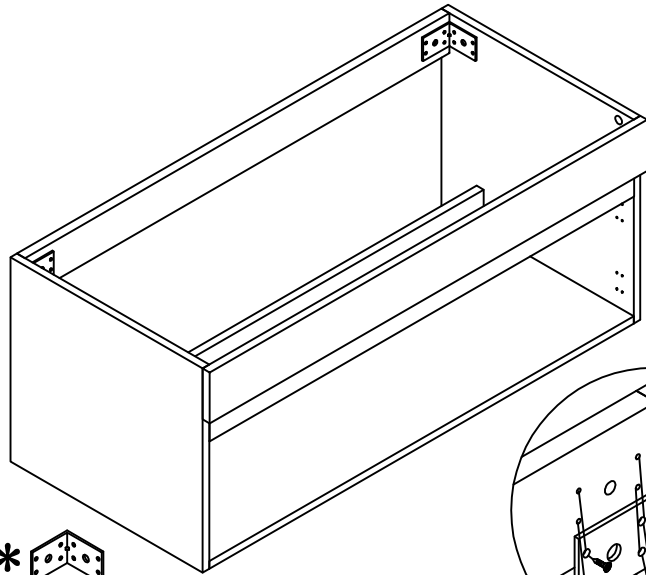

9



H-H=2* 
 I=16* 

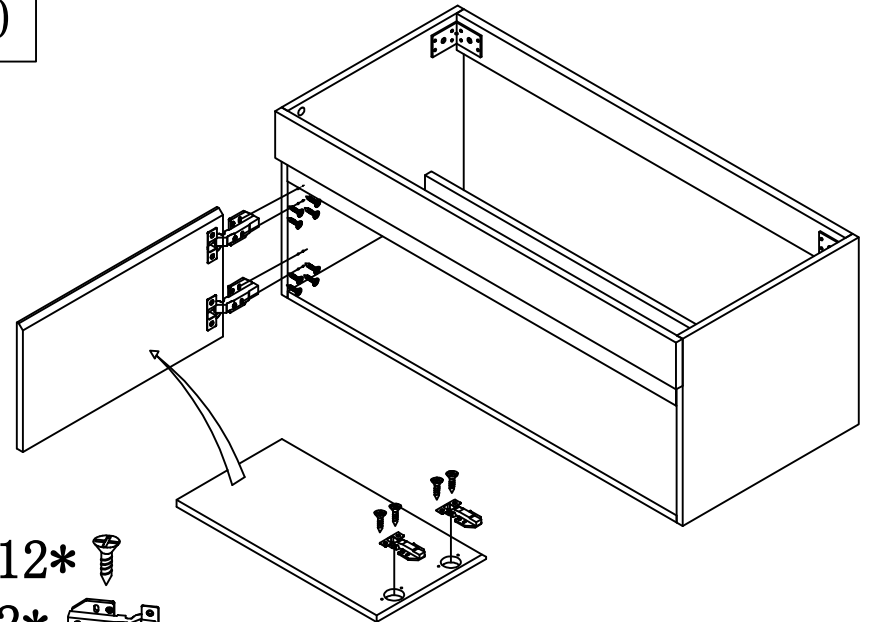

10

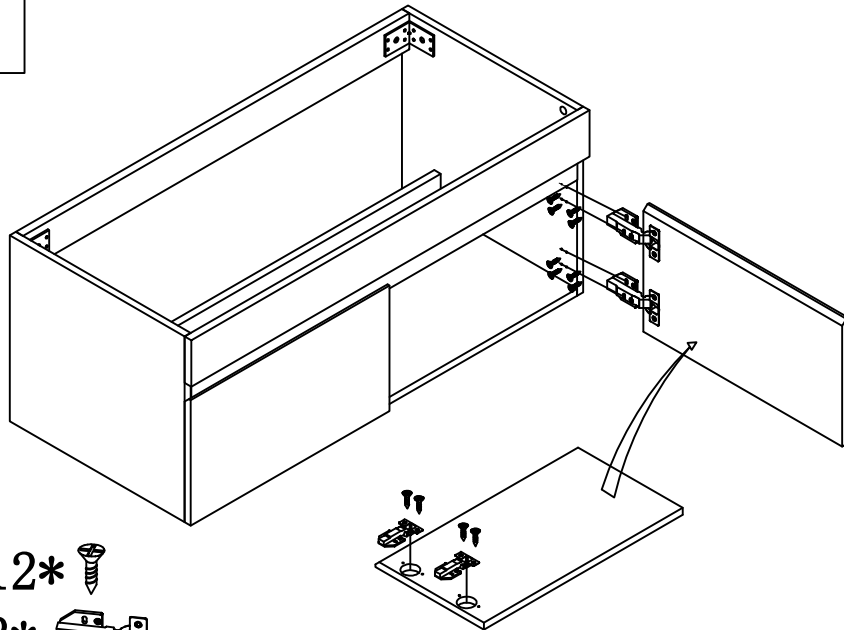

I=12* 
 G=2* 

11



I=12* 
 G=2* 

12

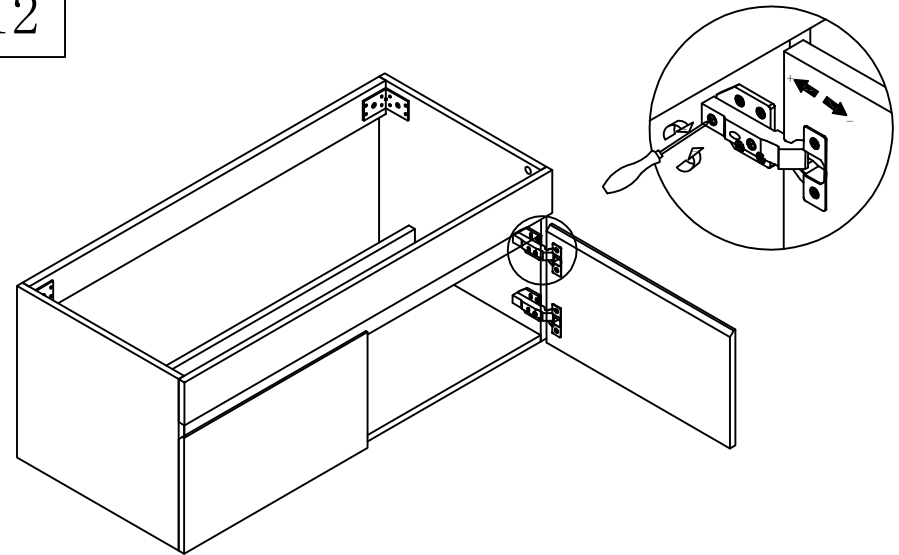

13

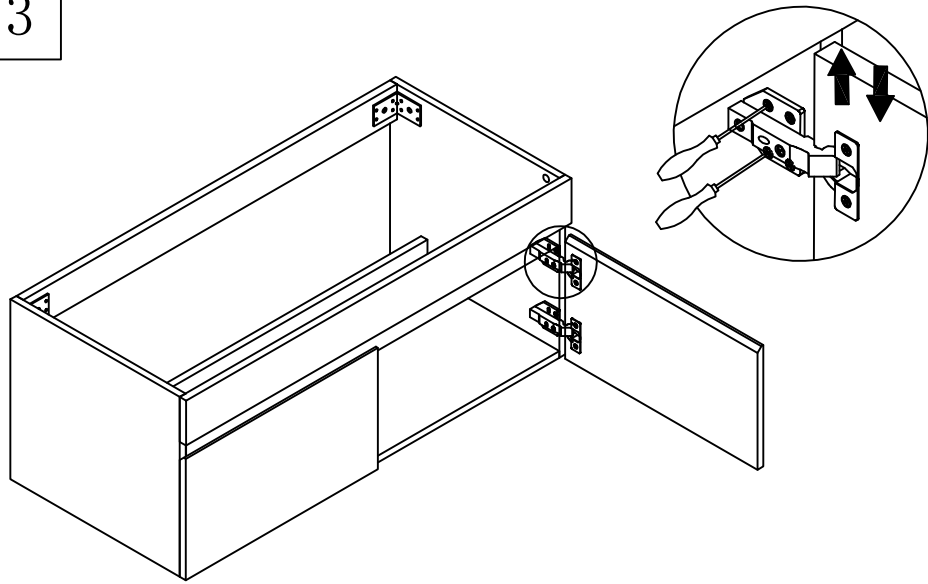

14

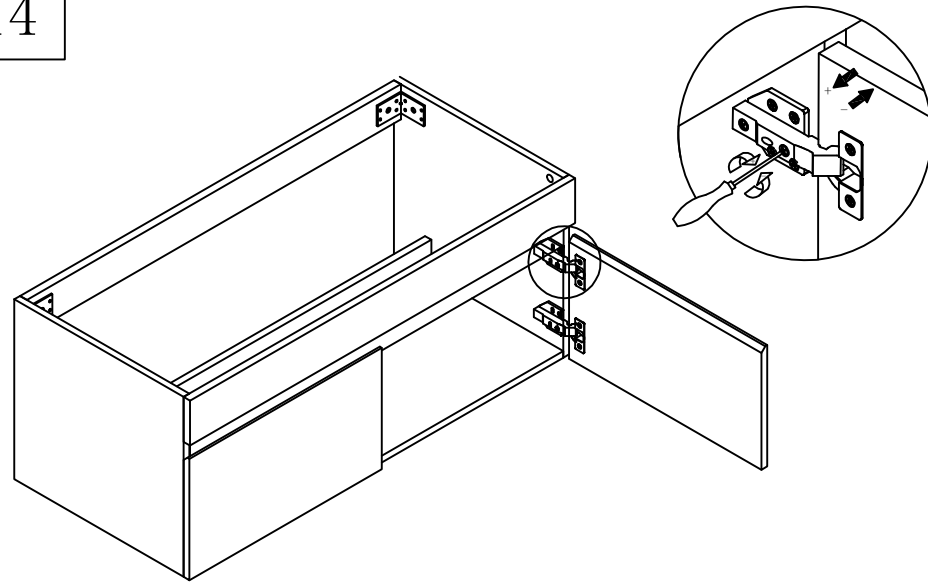

15

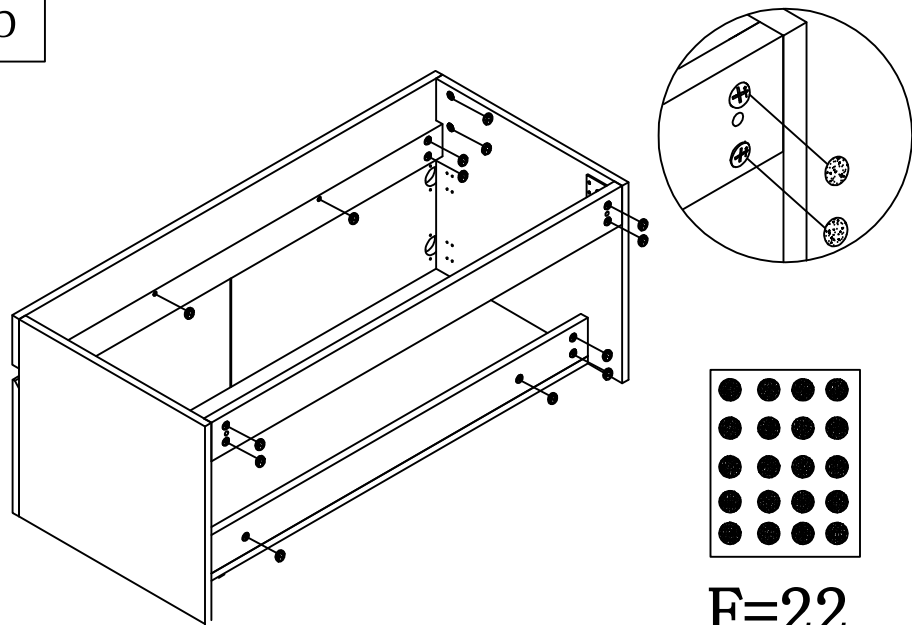

F=22

16

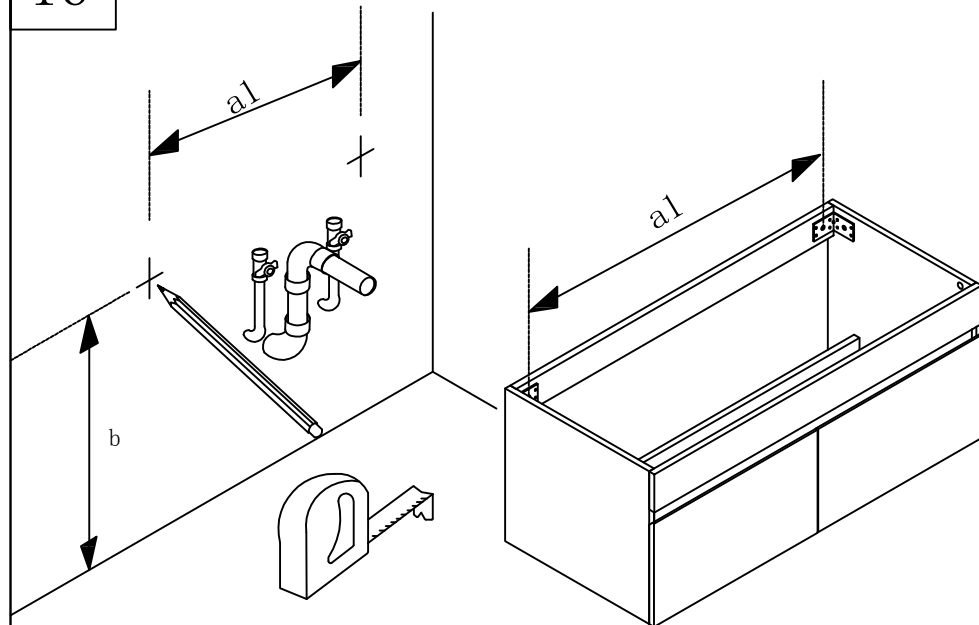

17

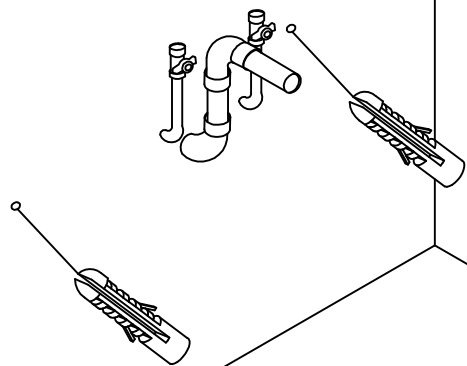

K=2*



18

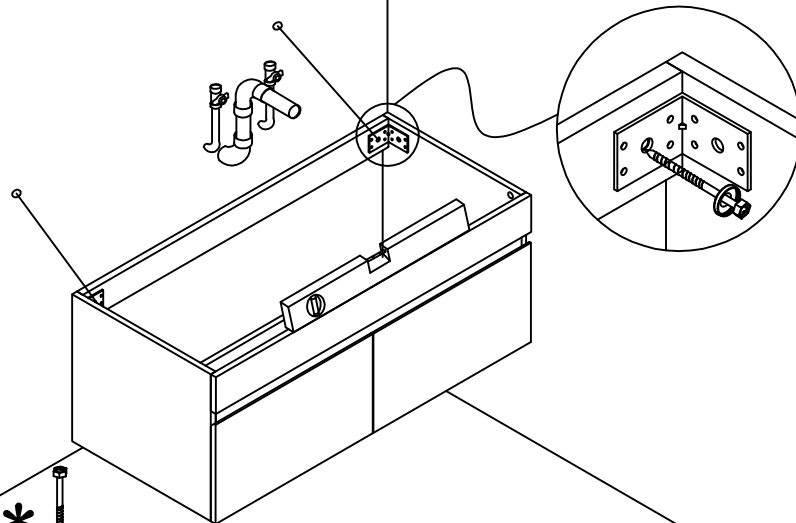

L=2*



J=2*



19

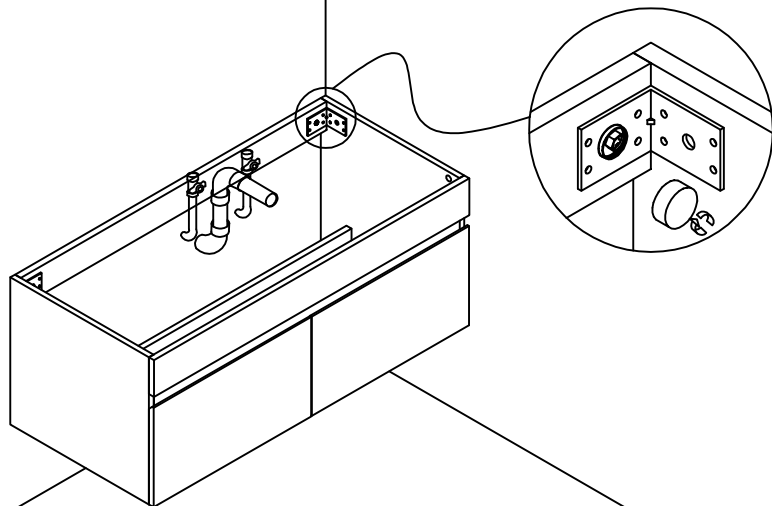

J=2*



20

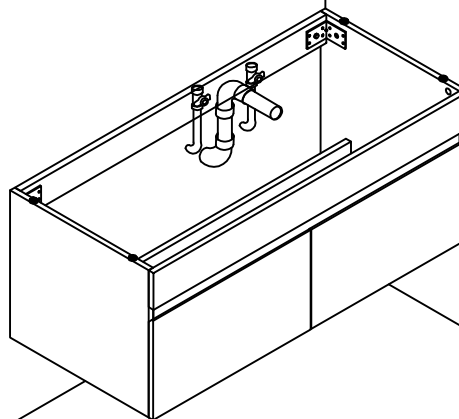

OK!

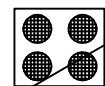

P=4